

Data and AI

Getting Ready For Db2 13

TRIDEX DB2 z/OS - 4Q2022 Meeting
December 1, 2022

John Lyle
Senior Software Engineer and PDM Team Lead
Db2 for z/OS Development

Agenda

- Db2 Continuous Delivery Review
- Db2 12 Function Level Journey
- Migration plans/paths to Db2 12 Function level M510
- Db2 13 Migration
- Fallback and Release Coexistence
- Summary
- Questions?



***Continuous
Delivery Review***

Continuous Delivery – What is it?

- From the IBM DB2 12 for z/OS Technical Overview Redbook (December 2016)
- <https://www.redbooks.ibm.com/redbooks/pdfs/sg248383.pdf>

“Each DB2 version delivers many enhancements in different areas that are welcomed by customers worldwide. However, sometimes certain functionalities are required sooner than the scheduled date of the next version. New release migration is also costly and time-consuming. Waiting for years to receive the much needed features in the next version might be impossible for certain business needs, thus the enhanced features must be retrofitted to the version in the current service stream. **Continuous delivery is a solution to make enhancements available in the service stream sooner than the next version.**”

- Notice that we used ‘DB2’ in 2016 and now use ‘Db2’ (starting in 2017)!

Db2 Continuous Delivery Review

- With Continuous Delivery, there is a **single delivery mechanism for defect fixes and enhancements**
 - PTFs (and collections of PTFs like PUTLEVEL and RSU) → same as today
- With Continuous Delivery, there are **five** Db2 for z/OS levels:
 - **Maintenance level (ML)** – changes with maintenance
 - Also known as code level - contains defect and new enhancement fixes
 - Some new functions are shipped disabled until the appropriate new function level is activated
 - **Catalog level (CL)** – function level prerequisites - cumulative (bundling possible)
 - **Function level (FL)** - needs to be activated - cumulative (skip level possible)
 - Introduces new Db2 features and functionality
 - No impact or change in existing application behavior
 - **APPLCOMPAT level (AC)** - set by application - provides an “island of stability” for a given application
 - AC level in BIND/REBIND of package must be <= current FL and overrides ZPARM
 - AC must be advanced to exploit new SQL function
 - Even if FL is regressed to an earlier level new function continues to be used by that application
 - **clientApplCompat level** - driver configuration keyword allows remote apps access to new functions

Group Display for Function Levels

- The display itself will show you at a group level, where you are and where you have been with the **HIGHEST ACTIVATED AND HIGHEST POSSIBLE** levels

- You would still see the '*' level if you went forward and fell back

-DISPLAY GROUP DETAIL

...

```
*** BEGIN DISPLAY OF GROUP(.....) CATALOG LEVEL (V12R1M500)
CURRENT FUNCTION LEVEL (V12R1M100)
HIGHEST ACTIVATED FUNCTION LEVEL (V12R1M100)
HIGHEST POSSIBLE FUNCTION LEVEL (V12R1M100)
PROTOCOL LEVEL (2)
GROUP ATTACH NAME (.....)
```

Catalog level (CL)

Function level (FL)

DB2					DB2	SYSTEM	IRLM		
MEMBER	ID	SUBSYS	CMDPREF	STATUS	LVL	NAME	SUBSYS	IRLMPROC	
DB1A	1	DB1A	-DB1A	ACTIVE	121500	MVSA	DJ1A	DB1AIRLM	
DB1B	2	DB1B	-DB1B	ACTIVE	111500	MVSB	DJ1B	DB1BIRLM	
DB1C	3	DB1C	-DB1C	ACTIVE	121500	MVSC	DJ1C	DB1CIRLM	

Maintenance level (ML)

- What if I try and active FL M500 now?

GROUP NOT ELIGIBLE FOR FUNCTION LEVEL (V12R1M500)
MEMBER(S) NOT STARTED WITH REQUIRED CODE LEVEL

- Due to there being an active Db2 11 member

Chronological View of Function Level Details

- Querying SYSIBM.SYSLEVELUPDATES
 - Chronological view of function level details
 - Example of using abbreviated columns names:

	FUNCT_LVL	PREV_FL	HIGH_FL	CATALOG_LVL	OP
1_	V12R1M500	V12R1M100	V12R1M500	V12R1M500	M
2_	V12R1M500	V12R1M100	V12R1M500	V12R1M502	C
3_	V12R1M500	V12R1M100	V12R1M500	V12R1M503	C
4_	V12R1M500	V12R1M100	V12R1M500	V12R1M505	C
5_	V12R1M500	V12R1M100	V12R1M500	V12R1M507	C
6_	V12R1M500	V12R1M100	V12R1M500	V12R1M509	C
7_	V12R1M510	V12R1M500	V12R1M510	V12R1M509	F

	OPERATION_TEXT	TIME	MEMBER
1_	CATMAINT PROCESSING - DB2DEV	2016-06-27-07.31.11	DB2A
2_	CATMAINT PROCESSING - V12R1M502	2021-08-13-06.43.43	DB2A
3_	CATMAINT PROCESSING - V12R1M503	2021-08-13-06.43.45	DB2A
4_	CATMAINT PROCESSING - V12R1M505	2021-08-13-06.43.45	DB2A
5_	CATMAINT PROCESSING - V12R1M507	2021-08-13-06.43.45	DB2A
6_	CATMAINT PROCESSING - V12R1M509	2021-08-13-06.43.45	DB2A
7_	-ACTIVATE FUNCTION LEVEL (V12R1M510)	2021-08-13-06.44.54	DB2A

- **** Note **** Only 8 of 9 columns are being displayed

Db2 Continuous Delivery Review

- New function/enhancements will be delivered via the maintenance stream in the form of new Function Levels
 - Customers should continue with the 'best practice' of 3-4 preventative service drops a year, continue to absorb fixes as well as dormant new function level support
 - **Do not execute CATMAINT to elevate catalog level (CL) until certain maintenance level that supports that new catalog level will not be backed off**
 - Once base code and (if necessary) catalog are at the appropriate level **–ACTIVATE FUNCTION LEVEL (V12R1M500)** command (as well as batch job option) allows that new function to be exploited
 - APPLCOMPAT bind option for static packages, dynamic JCC packages, as well as ZPARM → DML, DCL, DDL
 - Now APPLCOMPAT covers more than just DML due to continuous delivery needs
 - E.g., ALTER TABLE ALTER COLUMN to run as a pending alter requires APPLCOMPAT V12R1M500 or above, otherwise will default to an immediate alter
 - **New SQL functionality available in V12R1M500...501, etc. cannot be used until package is bound with APPLCOMPAT value of V12R1M50x**
 - Remember the ZPARM is always bringing you 'down'-level, so coordinate ZPARM and application changes on an aggressive schedule to up-level them
 - Be wary of NEW packages picking up ZPARM default, like NULLID packages, or Db2 Connect License
 - Recommended SQLLEVEL in DSNHDECP be set the the current activated function level
- **CURRENT APPLICATION COMPATIBILITY** special register for dynamic SQL



***Db2 12 Function
Level Journey***

Db2 13 – Setting the Context for New Innovation

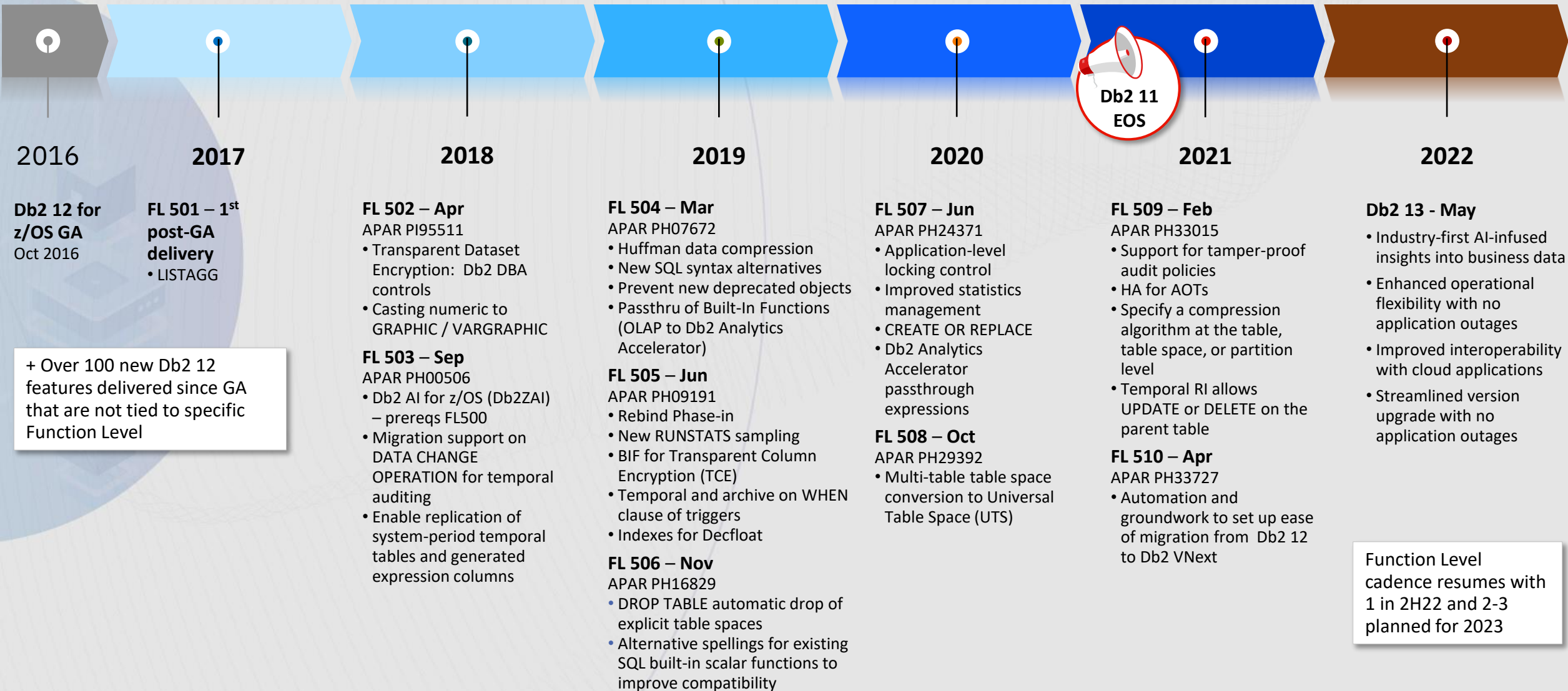

Activating Function Levels

- Can skip function levels if desired
 - Can return to an earlier function level, 'star' function level

Cool

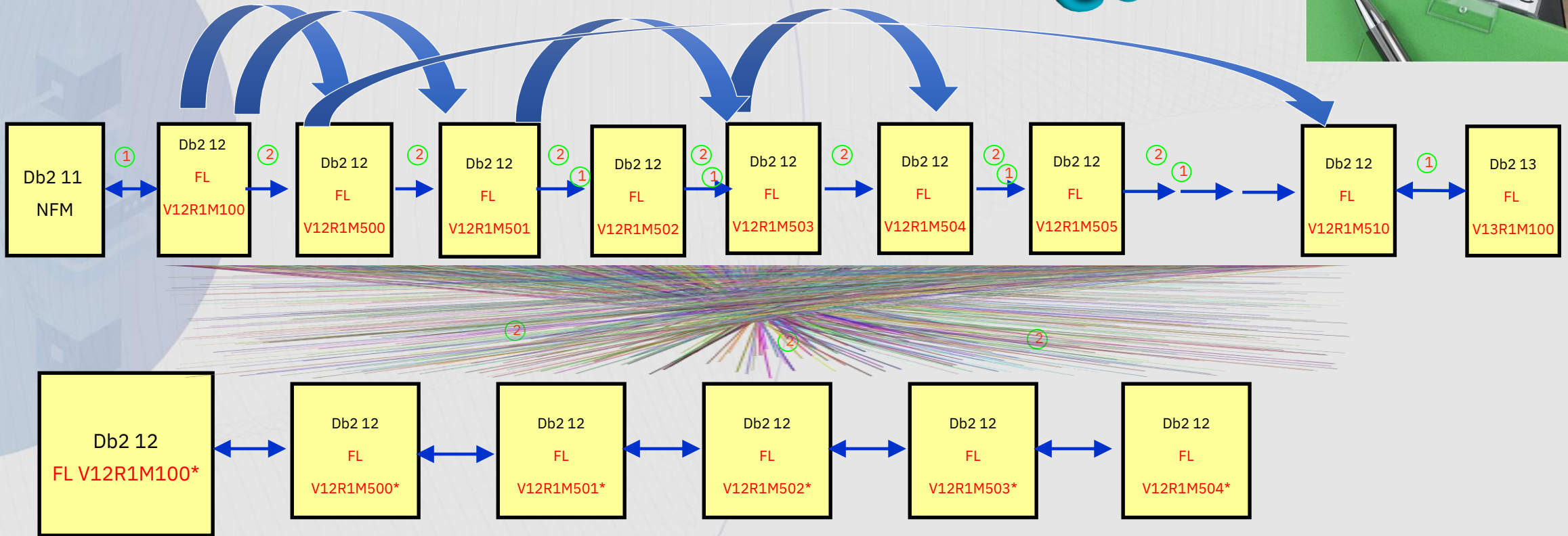

1 DSNTIJTC job
2 DSNTIJAF job or ACTIVATE command

Function and Member Code Levels

- Can only activate to a function level if **all** active members in a data sharing group are running with a level of code that understands the new function level!
 - Very much like fallback SPE code for release boundary



- **Each subsystem has its own code level.** Same format as catalog and function levels (i.e. V12R1M500)

- Each group member's code level can be different





***Db2 12 Catalog
Changes***

Db2 12 Catalog Changes ...

- Post GA catalog changes in Db2 12
 - **Function levels V12R1M502, V12R1M503, V12R1M505, V12R1M507 and V12R1M509 have catalog changes:**
 - **Catalog changes can be bundled. For example:**
 - **CATMAINT (DSNTIUTC)** job specifying a level of V12R1M509
 - Will make all 5 required CATMAINT changes (or as many as necessary to get to a V12R1M509 catalog level):
 - V12R1M502, V12R1M503, V12R1M505, V12R1M507 and V12R1M509
 - **No need to do 5 separate CATMAINT jobs!!**
 - Specifying a catalog level of V12R1M509 or V12R1M510 gets you to the same catalog level since there is no catalog change for V12R1M510.
 - CATMAINT processing figures out the current catalog level and determines what processing needs to be done to take the catalog to the specified level.

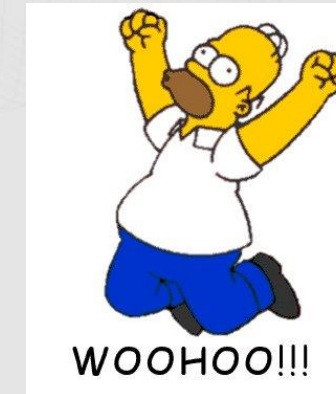

Db2 12 Catalog Changes ...

- Catalog changes in Db2 12
 - Function levels **V12R1M502, V12R1M503, V12R1M505, V12R1M507 and V12R1M509** have catalog changes:
 - **FL 502** - **KEYLABEL** column added to 4 catalog tables
 - SYSSTOGROUP, SYSINDEXES, SYSTABLES and SYSTABLESPACE
 - **FL 503** - Create **REPLICATION_OVERRIDE** global variable and GRANT READ access
 - **FL 505** – **COPYID** column added to 2 catalog tables
 - SYSPACKDEP and SYSPACKSTMT
 - **FL 507** – Create two global variables and GRANT READ access:
 - **SYSIBMADM. MAX_LOCKS_PER_TABLESPACE**
 - **SYSIBMADM. MAX_LOCKS_PER_USER**
 - **FL 509** - **COMPRESS_USED** column added to 1 table
 - SYSTABLEPART



Totals: 7 columns and 3 global variables in 5 CATMAINTs



Chronological View of Function Level Details

- SYSIBM.SYSLEVELUPDATES

- Chronological view of system updates: function, catalog and maintenance details
 - Example of using abbreviated columns names:

	FUNCT_LVL	PREV_FL	HIGH_FL	CATALOG_LVL	OP	
1_	V12R1M500	V12R1M100	V12R1M500	V12R1M500	M	} 'Bundled'
2_	V12R1M500	V12R1M100	V12R1M500	V12R1M502	C	
3_	V12R1M500	V12R1M100	V12R1M500	V12R1M503	C	
4_	V12R1M500	V12R1M100	V12R1M500	V12R1M505	C	
5_	V12R1M500	V12R1M100	V12R1M500	V12R1M507	C	
6_	V12R1M500	V12R1M100	V12R1M500	V12R1M509	C	
7_	V12R1M510	V12R1M500	V12R1M510	V12R1M509	F	

	OPERATION_TEXT	TIME	MEMBER
1_	CATMAINT PROCESSING - DB2DEV	2016-06-27-07.31.11	DB2A
2_	CATMAINT PROCESSING - V12R1M502	2021-08-13-06.43.43	DB2A
3_	CATMAINT PROCESSING - V12R1M503	2021-08-13-06.43.45	DB2A
4_	CATMAINT PROCESSING - V12R1M505	2021-08-13-06.43.45	DB2A
5_	CATMAINT PROCESSING - V12R1M507	2021-08-13-06.43.45	DB2A
6_	CATMAINT PROCESSING - V12R1M509	2021-08-13-06.43.45	DB2A
7_	-ACTIVATE FUNCTION LEVEL (V12R1M510)	2021-08-13-06.44.54	DB2A

- ** Note ** Only 8 of 9 table columns are being displayed

Db2 12 Function Level Incompatibilities

- Best Practice:
 - While Db2 allows for a great deal of flexibility in how to move forward and backward between function levels, we **highly recommend that you pay attention to any incompatibilities that are introduced in the function levels above the function level you're currently at.**
 - **For example:** If your current function level is V12R1M503 and you're wanting to move to function level V12R1M507, look at the incompatibilities for function levels 504 to 507 inclusive.
 - Resolve any gotchas before activating a higher function level whether you're skipping function levels or not.

Db2 12 Function Level Incompatibilities

- Incompatible changes summary for Db2 12 function levels

<https://www.ibm.com/docs/en/db2-for-zos/12?topic=12-function-level-501-higher>

- In Db2 12 the following function levels have incompatible changes :

- **FL 502**

- Only if UDFs are named GRAPHIC or VARGRAPHIC

- **FL 503**

- Result change for system-period temporal tables defined with ON DELETE ADD EXTRA ROW
- SET_MAINT_MODE_RECORD_NO_TEMPORALHISTORY stored procedure is not supported when APPLCOMPAT is V12R1M503 or higher

- **FL 504**

- **Next two slides**

- **FL 505**

- RUNSTATS does not update real-time statistics by default
- Newly supported user-defined functions

- **FL 506**

- Changes in explicitly created table space behavior

Db2 12 Function Level Incompatibilities ...

- **FL 504**

- Function level 504 introduces no incompatible changes. However, be aware of changes that might impact your Db2 environment applications for packages bound at APPLCOMPAT(V12R1M504) or higher, such as the following changes:

- If your Db2 applications have unqualified references to existing user-defined functions, they might start invoking new built-in functions instead if the names and signatures match, in certain situations. For information about avoiding such situations, see [Ensuring that Db2 executes the intended user-defined function](#).
- If your Db2 environment contains existing columns or variables with names such as CURRENT_TIMEZONE or CURRENT_SERVER, you must modify your applications to delimit these names. For example, you can issue the following queries to identify columns and variables with these names. For columns, issue:
 - COMPAT(V12R1M504) or higher, such as the following changes:

```
SELECT * FROM SYSIBM.SYSCOLUMNS
WHERE NAME IN('CURRENT_SERVER', 'CURRENT_TIMEZONE');
```

- For variables, issue:

```
SELECT * FROM SYSIBM.SYSVARIABLES
WHERE NAME IN('CURRENT_SERVER', 'CURRENT_TIMEZONE');
```

- Based on the result, you can check dependencies, for example by querying SYSIBM.SYSPACKDEP catalog table, to identify any static applications that depend on nondelimited forms of names

Db2 12 Function Level Incompatibilities ...



• FL 504

- CREATE TABLESPACE statements that previously created non-UTS segmented or partitioned table spaces, now always create partition-by-growth (PBG UTS) or partition-by-range (PBR UTS) tablespaces
 - After activating function level M504 and using an APPLCOMPAT value greater than or equal to V12R1M504, there are restrictions on DDL against legacy table space types
- The following SQL statements now return errors:
 - CREATE SYNONYM statements
 - CREATE TABLE statements that specify existing non-UTS tablespaces
 - CREATE TABLE and ALTER TABLE statements that specify ORGANIZE BY HASH
- Unless UTS migration is complete prior to function level M504 and the packages executing DDL are bound with function level M504+
 - To manipulate non-UTS objects, special register needs to be set:
 - **CURRENT APPLICATION COMPATIBILITY** to less than **V12R1M504**





***Function Level
V12R1M510***

V12R1M510 – Last Db2 12 Function Level

- Little to no new release function
 - None gated by function level
- Prerequisite catalog level is V12R1M509
- **Can only migrate to Db2 13 from FL V12R1M510**
 - **Plus fallback SPE code (PH37108/UI79956)**



V12R1M510 – Last Db2 12 Function Level ...

- V12R1M510 Fencing:

- V12R1M510 activation will be prevented if there are any (> 0) packages actively being executed whose RELBOUND value is from before V11 (n-2+) and have a LASTUSED value that's less than or equal to 18 months (548 days):

```
SELECT * FROM SYSIBM.SYSPACKAGE
WHERE LASTUSED >= DATE(DAYS(CURRENT DATE) - 548)
AND RELBOUND NOT IN ('P','Q','R')
AND VALID <> 'N' AND OPERATIVE <> 'N';
```



- This should prevent AUTOBIND situations that can be problematic once a new release migration completes
- **DSNTIYPE** (Db2 12)/**DSNTIJPM** (Db2 13) jobs will have this same query
- Run the above query **now** to see if you have anything that needs to be resolved prior to the activation of FL V12R1M510



Db2 12 Catalog Changes

- Quickest way to get from function level V12R1M100 to V12R1M510?
 - **Can quickly be done in just three steps!**



Assumption: all active members are running on a V12R1M510 code level

1. **ACTIVATE FUNCTION LEVEL (V12R1M500) or (V12R1M501)**
2. **CATMAINT (DSNTIJTC)** job specifying a level of V12R1M509
 - Will make as many of the Db2 12 catalog changes as is necessary (V12R1M502, V12R1M503, V12R1M505, V12R1M507 and V12R1M509) to get the catalog to the last Db2 12 catalog level (V12R1M509)
3. **ACTIVATE FUNCTION LEVEL (V12R1M510)**



- **Note:** As stated earlier in the presentation, pay attention to incompatibilities and other restrictions introduced in all of the function levels between where you currently are and including where you're wanting to move to.





***Migration
Plans/Paths to
Function Level
V12R1M510***

Migration Plans/Paths to Db2 12 Function Level V12R1M510

- Continuous delivery offers enhanced flexibility during the journey through Db2 12 function levels
 - Scenario, currently at FL501 and objective is to get to FL510
 - 5 Catalog Levels need to be completed in journey to FL510 (FL502, FL503, FL505, FL507, FL509)
 - **CATMAINT(s) and activating a matching function level do not need to occur at the same time**
 - Not all Function Levels require a catalog level change (CATMAINT)
 - Can be executed during the same change window
 - **CATMAINT(s) can be executed well in advance and function levels activated at a later point in time**
 - Options:
 1. **Each CATMAINT can be executed separately**
 - During the same change window
 - Incrementally over time
 2. Allow Db2 to determine the CATMAINT(s) that are needed
 - **CATMAINT(s) can be run well in advance i.e.,**
 - Catalog level M509
 - **Function level activation can occur at a later point in time**
 - Incrementally when ready M502 ... M505 ... M509 ... M510
 - Jump to latest level M509/M510
 - Incompatibilities need to be reviewed and acted on before moving to chosen Function Level
 - After activating a function level i.e., it is possible to revert to an older Function Level
 - DSNU757I shows result of the ACTIVATE FUNCTION LEVEL command

	FUNCT_LVL	PREV_FL	HIGH_FL	CATALOG_LVL	OP
1	V12R1M500	V12R1M100	V12R1M500	V12R1M500	M
2	V12R1M500	V12R1M100	V12R1M500	V12R1M502	C
3	V12R1M500	V12R1M100	V12R1M500	V12R1M503	C
4	V12R1M500	V12R1M100	V12R1M500	V12R1M505	C
5	V12R1M500	V12R1M100	V12R1M500	V12R1M507	C
6	V12R1M500	V12R1M100	V12R1M500	V12R1M509	C
7	V12R1M510	V12R1M500	V12R1M510	V12R1M509	F

	OPERATION_TEXT	TIME	MEMBER
1	CATMAINT PROCESSING - DB2DEV	2016-06-27-07.31.11	DB2A
2	CATMAINT PROCESSING - V12R1M502	2021-08-13-06.43.43	DB2A
3	CATMAINT PROCESSING - V12R1M503	2021-08-13-06.43.45	DB2A
4	CATMAINT PROCESSING - V12R1M505	2021-08-13-06.43.45	DB2A
5	CATMAINT PROCESSING - V12R1M507	2021-08-13-06.43.45	DB2A
6	CATMAINT PROCESSING - V12R1M509	2021-08-13-06.43.45	DB2A
7	-ACTIVATE FUNCTION LEVEL (V12R1M510)	2021-08-13-06.44.54	DB2A

Db2 Enhanced Migration Functionality

- Online Migration Problem

- Customer unable to:

- Successfully complete online migration
 - Determine when a system is likely compatible with online migration
 - Identify applications that are incompatible with online migration

- Goal

- Help system administrators identify applications/processes that are incompatible with online migration
 - Pre-migration options
 - Change applications/processes to be compatible
 - Plan migrations around incompatible applications/processes
 - Take other alternative mitigating steps i.e., stopping online monitor

Db2 Enhanced Migration Functionality ...

- Online Migration Solution

- Provide instrumentation to identify most common online migration blockers

- Long running Catalog and Directory lock holders
 - Long running claims and drains on the Catalog and Directory
 - Package locks
 - Lock creation timestamp will be provided as well as the duration of how long the lock(s) are held
 - Dynamic statement cache where the statement involves the Catalog and Directory

- Online Migration Solution Design

- Two methods are provided in Db2 11+ for users to obtain information about potential migration BLOCKERS

- **BLOCKING_THREADS** function
 - **DISPLAY BLOCKERS** command

- System databases were the initial design target

- Can be used for any database
 - Output sorted by lock duration time in descending order
 - APAR PH10826/UI69855
 - IRLM pre-req APAR PH16439/UI65542

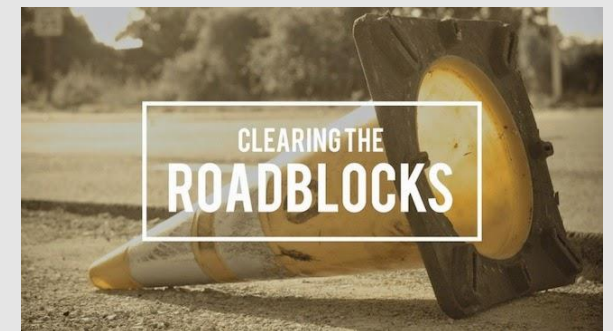

Db2 Enhanced Migration Functionality ...

- DISPLAY BLOCKERS



```

-DISPLAY BLOCKERS (DSNDB06,DSNDB01)
DSNT360I -DB2A *****
DSNT369I -DB2A * DISPLAY BLOCKERS SUMMARY REPORT
          * 2021-10-03-14.16.20.502389
DSNT360I -DB2A *****
DSNT397I -DB2A

-----
REPORT: DISPLAY BLOCKERS REPORT
-----
T LT DBNAME DBID NAME OBID AGE (SHORT) TOKEN MEMBER
-----
C 80 DSNDB06 0006 SYSTSQRY 06C1 2 H 3 M 10 DB2A
C 80 DSNDB06 0006 SYSTSDQY 08C2 2 H 3 M 10 DB2A
C 80 DSNDB06 0006 DSNQYX04 06CB 2 H 3 M 10 DB2A
C 80 DSNDB06 0006 DSNQX02 08DE 2 H 3 M 10 DB2A
C 80 DSNDB06 0006 SYSTSDQY 08C2 1 H 54 M 13 DB2A
C 80 DSNDB06 0006 DSNQYX04 06CB 1 H 54 M 13 DB2A
C 80 DSNDB06 0006 DSNQX02 08DE 1 H 54 M 13 DB2A
C 80 DSNDB06 0006 SYSTSQRY 06C1 1 H 54 M 13 DB2A
C 80 DSNDB06 0006 DSNKDX03 015A 0.005924 S DB2A
C 80 DSNDB06 0006 SYSTSPKD 0812 0.005924 S DB2A
-----
INFO: DIAGNOSTIC AND INFORMATIONAL MESSAGES
-----
T DBNAME MEMBER INFORMATIONAL DESCRIPTION
-----
I DSNDB01 NO LOCKS OR CLAIMS FOR THE DATABASE
-----
DSN9022I -DB2A DSNZACMD '-DISPLAY BLOCKERS' NORMAL COM
    
```



```

-DIS BLOCKERS (DSNDB06,DSNDB01) DETAIL
DSNT360I -DB2A *****
DSNT369I -DB2A * DISPLAY BLOCKERS DETAILED REPORT
          * 2021-10-03-14.16.20.829657
DSNT360I -DB2A *****
DSNT397I -DB2A

-----
REPORT: DISPLAY BLOCKERS REPORT
-----
T LT DBNAME DBID NAME OBID AGE (SHORT) TOKEN MEMBER
-----
C 80 DSNDB06 0006 SYSTSQRY 06C1 2 H 3 M 10 DB2A
      CONNID: BATCH
      CORRID: SELIPT
      AGE: 2 H 3 M 45.715939 S
      USERID: SYSADM
      LUWID: USIBMSY.SYEC1DB2.DA687DCF53DD=10
      DURATION: CM
      ACQUIRED: 2021-10-03-12.12.35.096816837890
-----
T LT DBNAME DBID NAME OBID AGE (SHORT) TOKEN MEMBER
-----
C 80 DSNDB06 0006 SYSTSDQY 08C2 1 H 54 M 13 DB2A
      CONNID: BATCH
      CORRID: SELLVLUP
      AGE: 1 H 54 M 37.298529 S
      USERID: SYSADM
      LUWID: USIBMSY.SYEC1DB2.DA687FDA5725=13
      DURATION: CM
      ACQUIRED: 2021-10-03-12.21.43.514227028320
    
```



- DISPLAY BLOCKERS DETAIL

Migration Plans/Paths to Db2 12 Function Level M510

- Db2 12 online migration testing methodology
 - In a non-production environment, the goal would be disruptive testing with the intent of producing the migration job to fail
 - In a non-production environment test the Db2 12 online migration job at the most disruptive time
 - If more than one non-production environment, choose different disruptive scenarios to migrate against
 - If you can produce a failure with normal activity, think about crashing Db2 during the migration to simulate a restart scenario
 - ***The ultimate objective is to acquire confidence in the process***
 - Migration is designed to recover from any failures
 - Restarting a failed migration step
 - Supplying as much noise and disruptive testing in worst case scenarios
 - **Db2 12 online migration should still be executed at a quiet time and after taking all necessary precautions**



Db2 13 Migration

Db2 13 Enhancements

Better Performance

- Better insert performance
- Reduce RACF contention
- Increased FTB eligibility
- IFI306 log read efficiency
- Improved castout processing
- Faster REORG INDEX

Greater Insight and Oversight

- GBP residency tracking
- Index page split tracking
- Better Lock/latch wait tracking
- Utility history

Better Availability

- Online conversion from PBG to PBR
- Online removal of active log datasets
- Improved ALTER TABLE serialization
- Statement-level dependency tracking

Better Scalability

- Support more open datasets
- Reduced storage footprint in ECSA and low private
- Improved storage contraction
- Better real storage management
- Quadruple max size of SPT01 and SYSLGRNX
- RTS improvements

Better Usability

- Application control of lock timeouts and deadlocks
- Better package ownership management
- Application profile support for local threads
- Profile support for package release, timeout and deadlock control
- ZPARM reduction and default improvements
- Better RECOVER support for part-level copies

Db2 13 Migration Process

- Can only migrate to Db2 13 from Db2 12 function level V12R1M510
 - Code on all active Db2 12 members must contain the fallback SPE code: **PH37108/UI79956**
- Catalog changes in Db2 13:
 - **There will be a release migration CATMAINT, but it will not contain any migration SQL!**
 - Sets internal level and release markers and updates the SYSLEVELUPDATES catalog table
 - Allows customers to control migration timing with CATMAINT
 - No Db2 12 fallback SPE code needed specifically for Db2 13 catalog changes because Db2 12 will never 'see' any Db2 13 catalog changes
 - Eliminates need for a great deal of fallback SPE code
 - Reduces large amount of internal testing effort
 - Huge reduction in recompiles needed in fallback SPE APARs (catalog macro changes and their recompiles are **not** needed as in previous releases)
 - **This is THE major migration enhancement for Db2 13**
 - **Db2 13 migrations won't fail due to contention with application programs, no AUTOBIND issues, Catalog and Directory RNA, etc. Much easier to migrate ONLINE!**
- Note: initial Db2 13 catalog level is V13R1M**100** (not VnnR1M500 as it was in Db2 12)



Db2 13 Migration and Fallback Paths

- Can only migrate to Db2 13 from Db2 12 function level V12R1M510
 - No skip release support
- Cannot fall back to Db2 12 after activating Db2 13 function level V13R1M500 or above
 - Can return to 'star' function level V13R1M100*

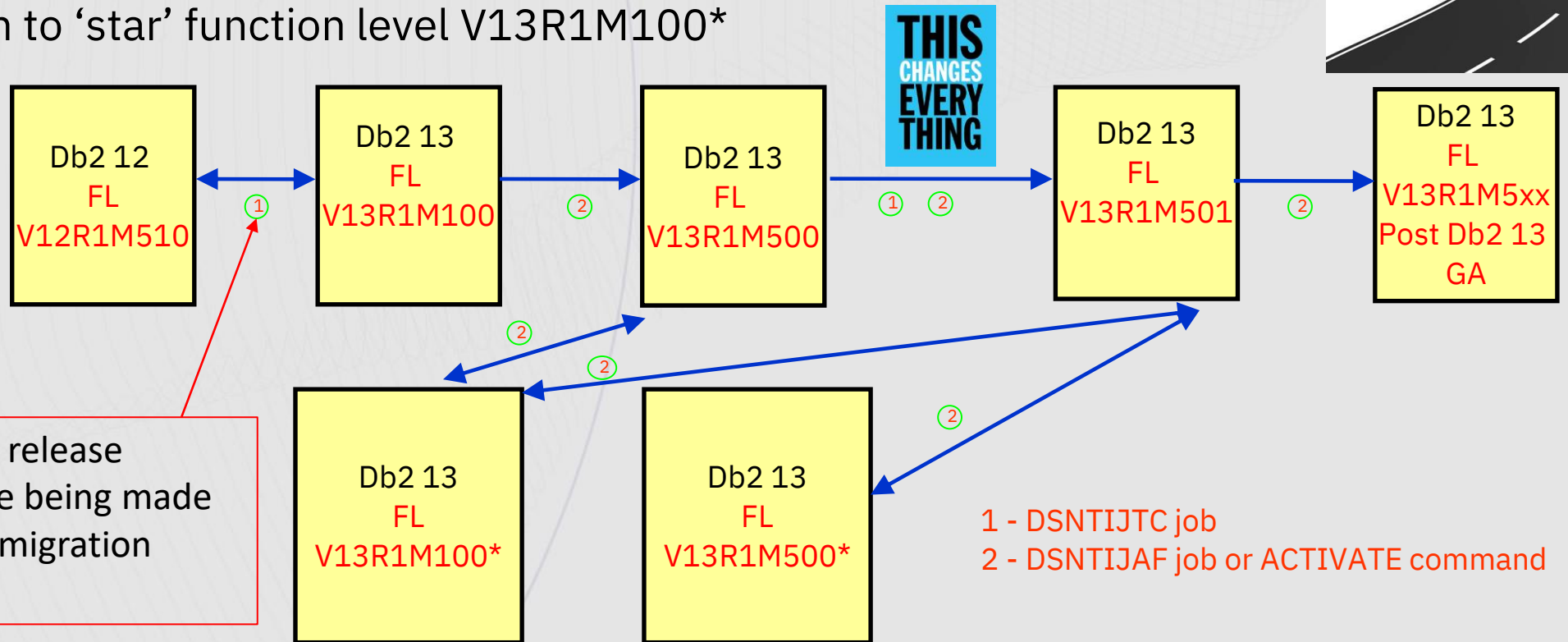

No traditional new release catalog changes are being made during the Db2 13 migration process!!

Db2 13 Catalog Changes

- First Db2 13 catalog changes are made **after** function level **V13R1M500** has been activated
 - No fallback capability once function level V13R1M500 has been activated
 - Db2 12 will therefore never be exposed to any Db2 13 catalog changes
- This catalog level is **V13R1M501**
- Function level **V13R1M501** can only be activated if the catalog level is **V13R1M501**
- Db2 13 development life cycle will follow the same Db2 12 continuous delivery model *

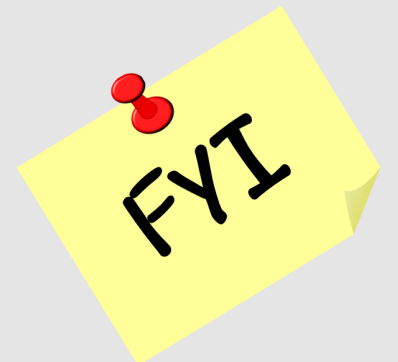

Db2 13 New Function Availability

- New function/enhancements will be delivered via the maintenance stream in the form of new Function Levels. Same as in Db2 12.
- New function that **does** require a Db2 13 catalog change will be available in a function level that comes **AFTER** the catalog change is made. At GA time, this would be catalog level **V13R1M501**.
- **Notes:**
 - Not all new Db2 13 functions are tied to a function level
 - Lots of new function will be available in Db2 13 on GA day
 - Post GA implications?
 - Some new function requires an appropriate APPLCOMPAT level to exploit

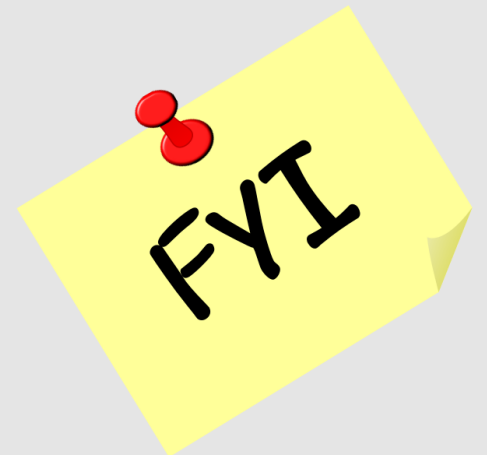

Db2 13 New Function Availability

- Function level V13R1M502 available October 28th, 2022
 - First post-GA function level delivery
 - [PH47891](#)
 - No catalog changes
 - <https://www.ibm.com/docs/en/db2-for-zos/13?topic=levels-function-level-502-apar-ph47891-october-2022>





***Fallback and
Release
Coexistence
Stuff***

Capabilities in Db2 12 after falling back from Db2 13

- After falling back to Db2 12 or after stopping all Db2 13 members
 - The current function level is still: **V13R1M100**
 - No action was taken to change it so it remains the same as it was in Db2 13
 - You CAN ACTIVATE an earlier Db2 12 'star' function level after falling back to Db2 12
 - As long as there are no active Db2 13 members
- Can start up a V13 member and the function level will remain as it was in Db2 12.
 - No action was taken to change it.
- Highest possible function level will be different between a Db2 12 member and a Db2 13 member



***V13 End-of-Service
Date?***

Db2 13 End Of Service date?

- No EOS date has been announced



- Db2 13 is rich in functionality! So there is no need to wait until EOS to move to Db2 13!



Summary

- **Can get from function level V12R1M100 to V12R1M510 in only 3 steps**
 - Pay attention to function level incompatibilities
- **Can only migrate to Db2 13 from FL V12R1M510**
- **Migrations to Db2 13 are very different than they were in any previous release. Change is good!**
 - The catalog structure does **NOT** change during migration processing
 - Won't invalidate packages, etc. that have dependencies on catalog objects that change
 - Expectation for migrations to be fully online
 - Use DISPLAY BLOCKERS and/or BLOCKING THREADS during migration window to see if there are any blockers

IBM Db2 13 Redbook now available!

Take a read through the new IBM Redbook on Db2 13 for z/OS and its ecosystem

Get your copy at:

<https://www.redbooks.ibm.com/abstracts/sg248527.html>

Coming next!

Db2 13 for z/OS Performance Redbook

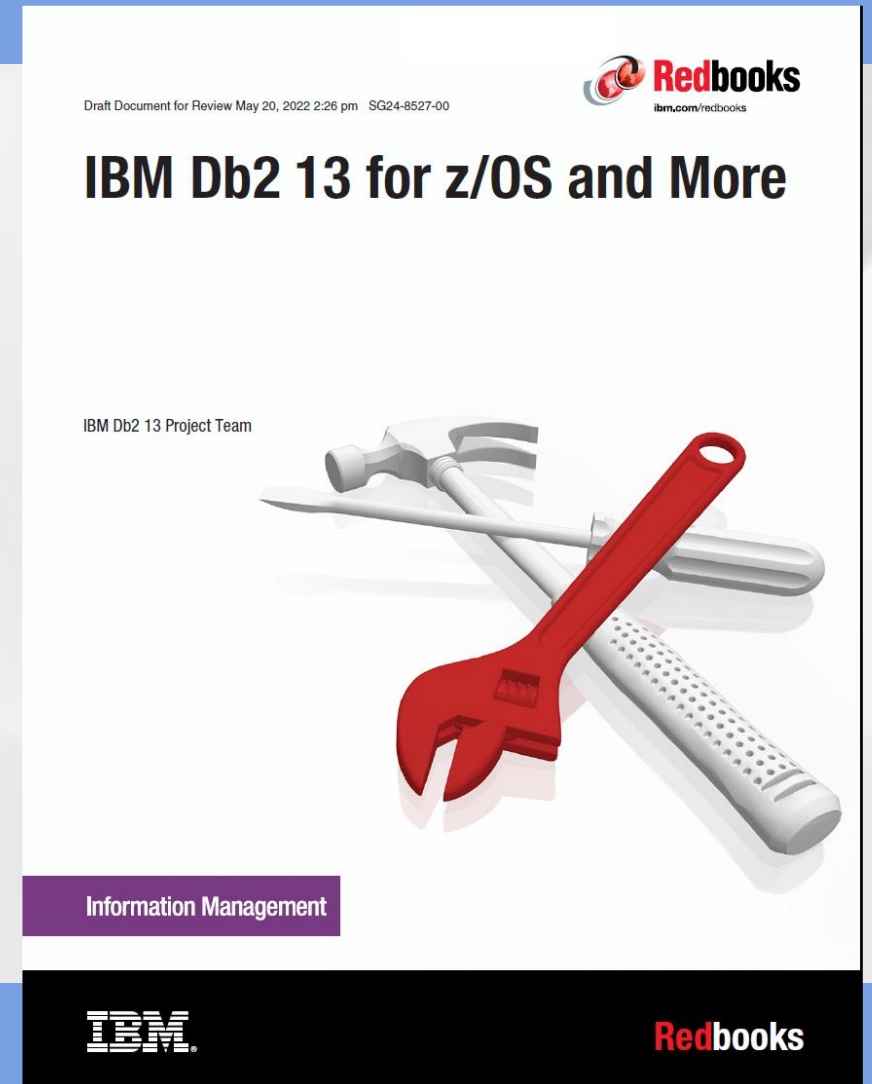

Thank You

IBM®

Getting Ready For Db2 13

TRIDEX DB2 z/OS - 4Q2022 Meeting

John Lyle

Senior Software Engineer and PDM Team Lead
Db2 for z/OS Development Lab
jlyle@us.ibm.com

IBM Data and AI

The IBM logo is located in the bottom right corner of the slide. It consists of the letters "IBM" in a bold, white, sans-serif font.